



Crate & Tunnel Washers

RC, RT



Rhima Australia

www.rhima.com.au

Rhima New Zealand

www.rhima.co.nz

Rhima Singapore

www.rhima.sg





HIGH CAPACITY AND POWERFUL WASH

The Rhima range of crate and tunnel washers can meet all requirements when it comes to washing crates, containers, pots, pans, utensils and all types of kitchenware or manufacturing utensils used for food processing. These washers represent the ideal solution for bakeries, patisseries, small goods and for the general food industry, which require a seamless flow of clean containers.

Several optional accessories are available to provide the best fit into the wash area space available and minimise the need for extra labour. Each model can be built left or right loading.

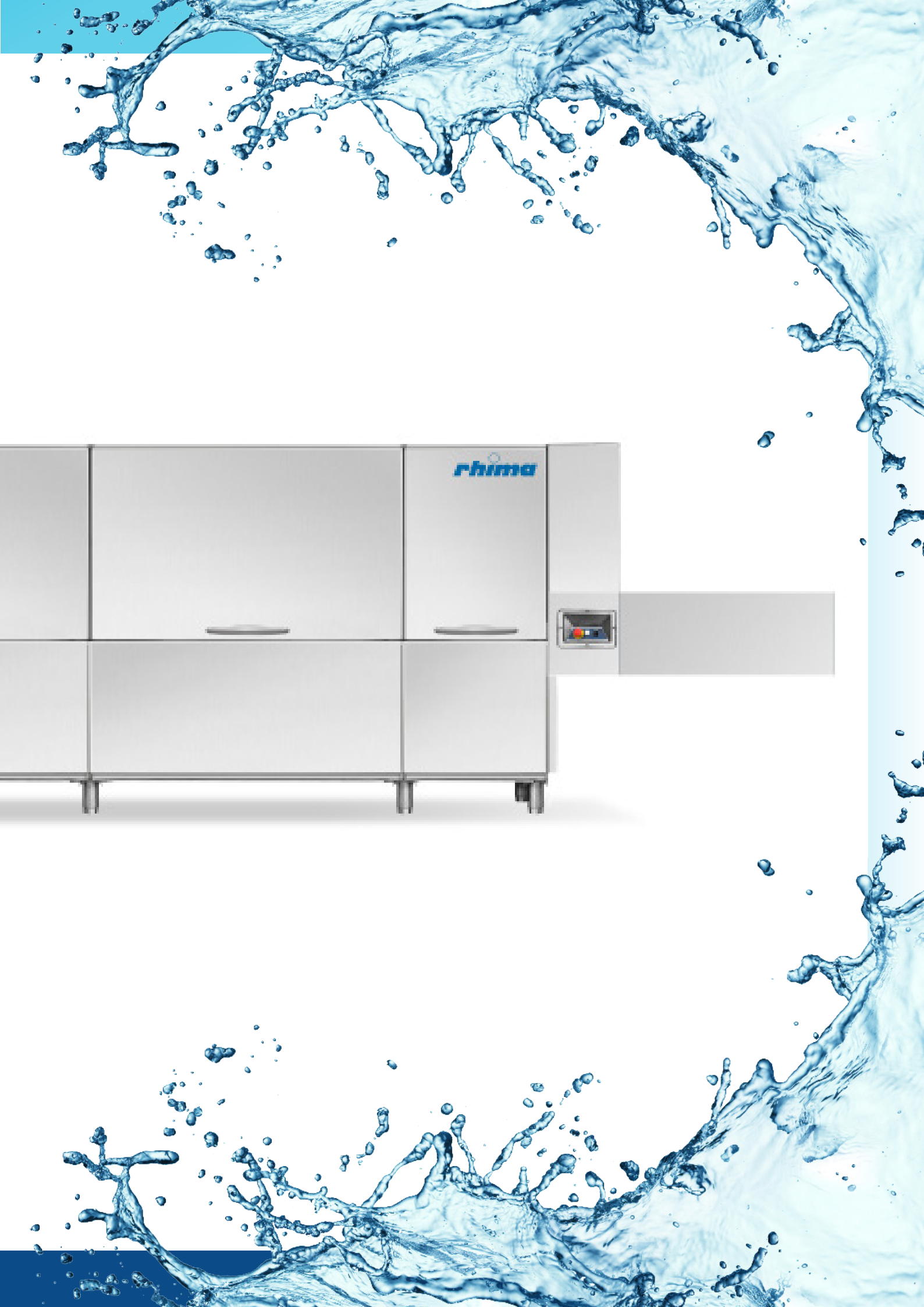

rhimo



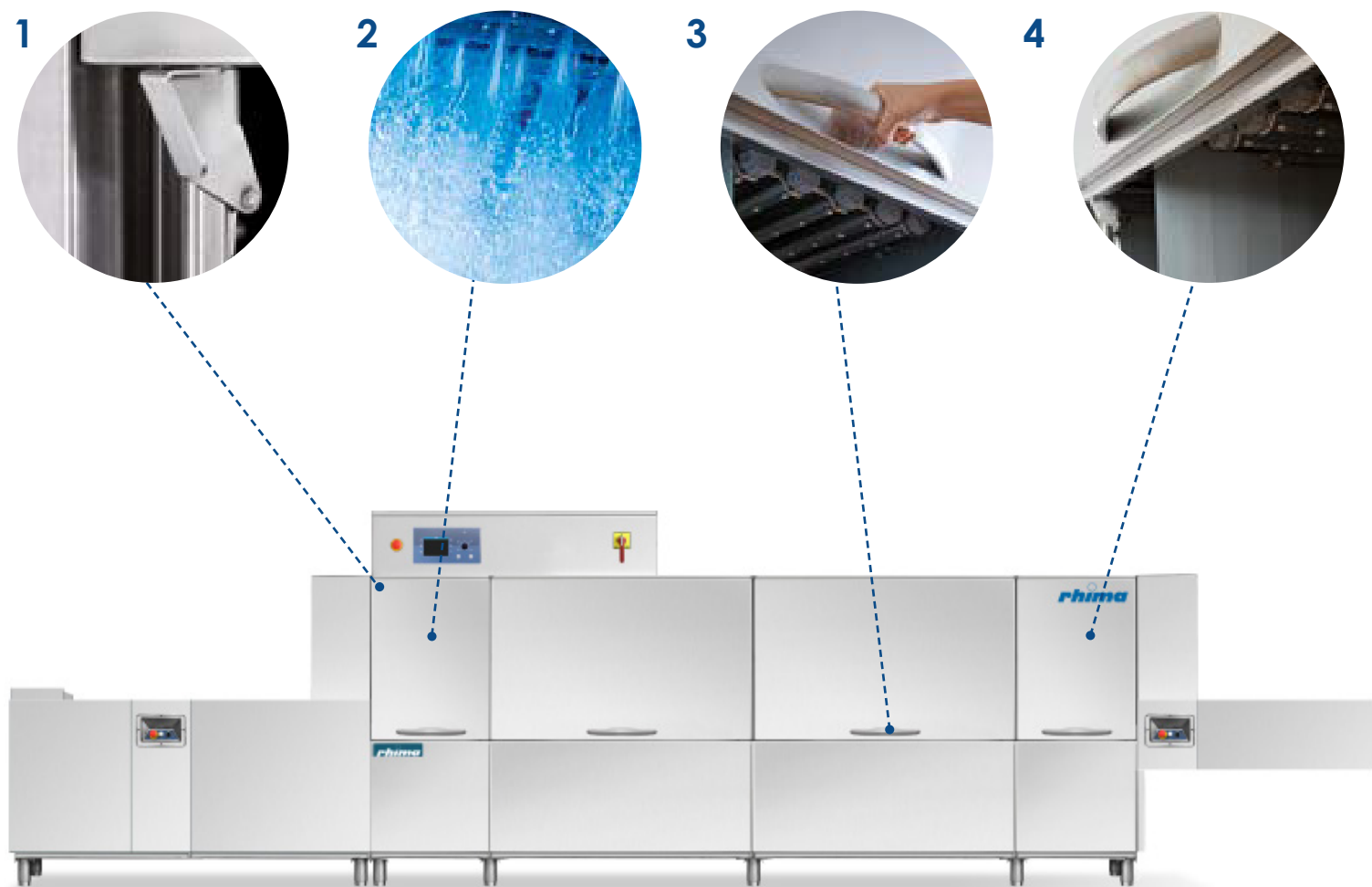

BENEFITS

1. Double skin, insulated and counterbalanced doors, equipped with anti-fall safety device. This is to save energy and allows for quieter operation
2. Double Rinse to achieve the needed sanitisation that your products require
3. Ergonomic handles for easy gripping when opening the doors
4. Inlet chute and splash-guard modules at both ends for ease of use and to prevent cross contamination



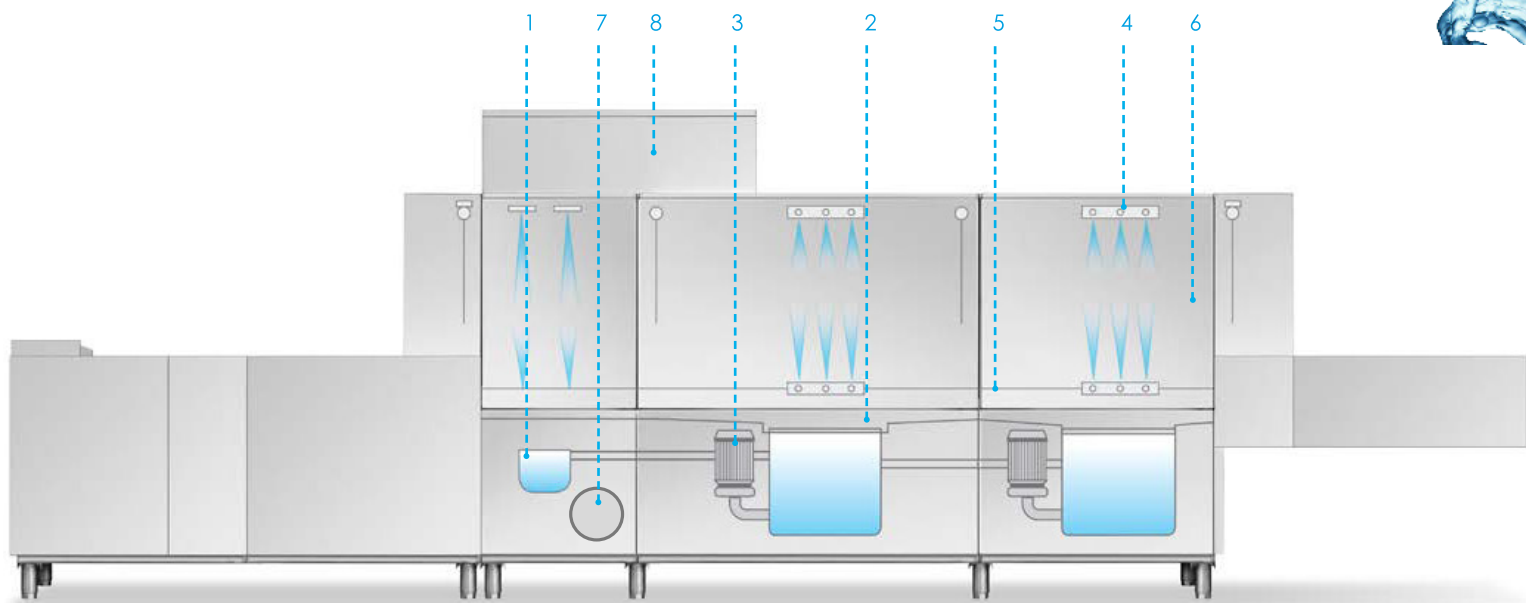

FEATURES

1. Radial wash tanks in AISI 316 stainless steel built to help empty the tanks easily
2. CLEAN+ filters which are easy to remove and keep the water clean and free of food scraps
3. Self-cleaning vertical wash pumps, protected from electrical overloads
4. Ability to adjust pressure on the wash and rinse arms
5. Belt advancement system with built-in clutch
6. Wash and rinse economisers
7. AISI 316 stainless steel boilers which are fully insulated to reduce thermal loss
8. Autotimer switching off the rack conveyor motor and all electrical options after a pre-set lapse of inactivity

RC SERIES WASHERS

The RC series crate washers have been designed to wash crates, tubs, bins and buckets of varying size for the food processing industries.

The working direction of this range can be ordered to suit different operations.

RC 231

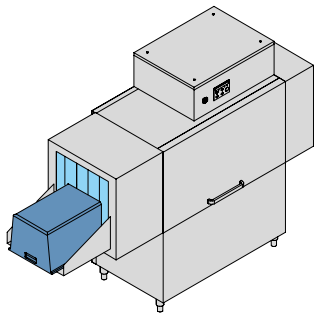

RC 231 Special

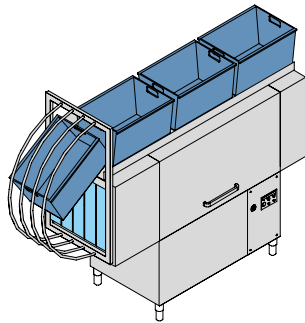

RC 281

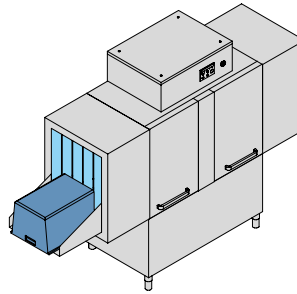

RC 301 /
RC 401

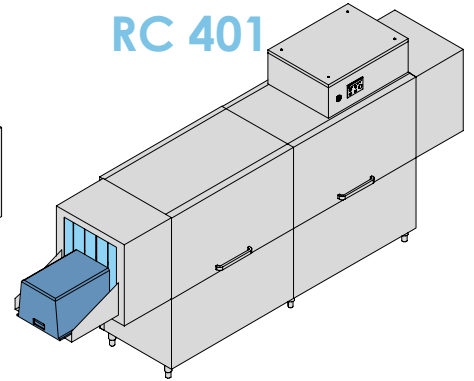

	H max	min < L1 < max	min < L2 < max
RC 301 - RC 401	500	400* < L1 < 510	400* < L2 < 510
RC 301 - RC 401 + Blower	500	400* < L1 < 510	400* < L2 < 510
RC 281	800	400* < L1 < 510	400* < L2 < 510
RC 231 Special	DIAGRAM	400* < L1 < 510	400* < L2 < 510
RC 301 Special	DIAGRAM	400* < L1 < 510	400* < L2 < 510
RC 401 Special	DIAGRAM	400* < L1 < 510	400* < L2 < 510

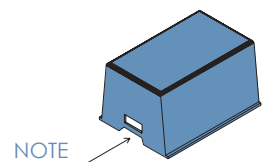
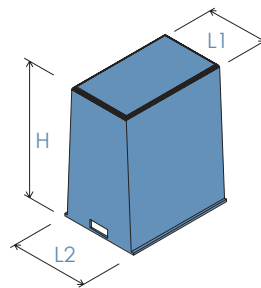
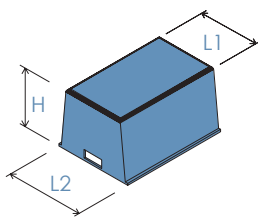

NOTE: Should you need to wash baskets with non-standard dimensions or with handles, our Rhima technicians can modify these machines to suit.

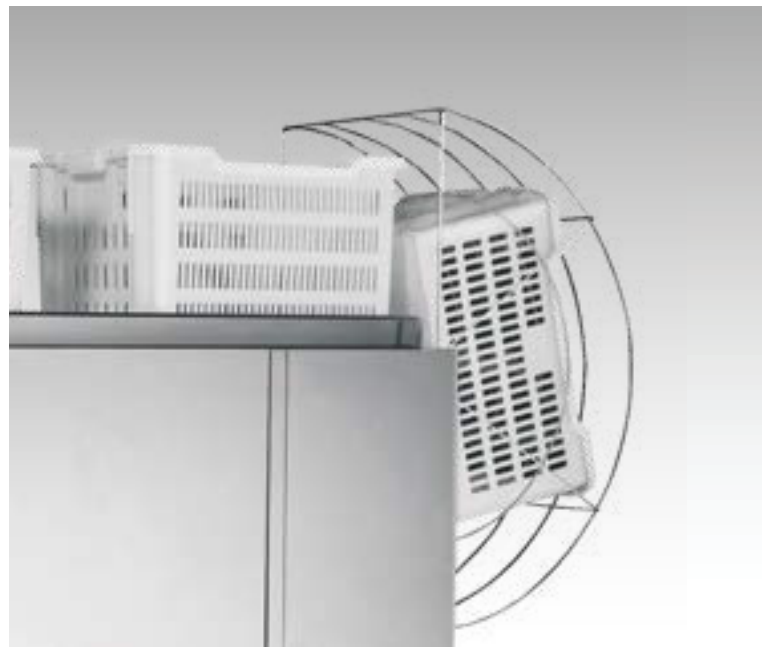

STANDARD FEATURES

- Two operating speeds
- Digital display and soft touch keyboard
- IPX5 electronic board, ensuring constant monitoring of operating parameters
- Ability to adjust pressure on the wash and rinse arms
- Middle-rail system, perfect to wash crates of any width. In addition, SPECIAL model is equipped with an innovative top-down loading system allowing a "one-person-only" operation
- Crates max. width 510mm/height 500mm
- Anti-contamination curtains to avoid cross contamination between tanks

OPTIONS

- Linear blowing zone, electric or steam heated, 4,5kw or 9Kw power, on shelf or dedicated module (with 2 standard turbo-blowers)
- Steam condenser (SC10)
- 3 available heat recovery systems (compact, standard or with built-in heat pump) to be chosen according to the type of machine
- Detergent pump
- Speed adjuster
- Water pressure security system Break Tank
- Extra power if hot water is not available

RC OPTIONAL BLOWERS

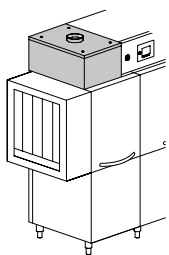
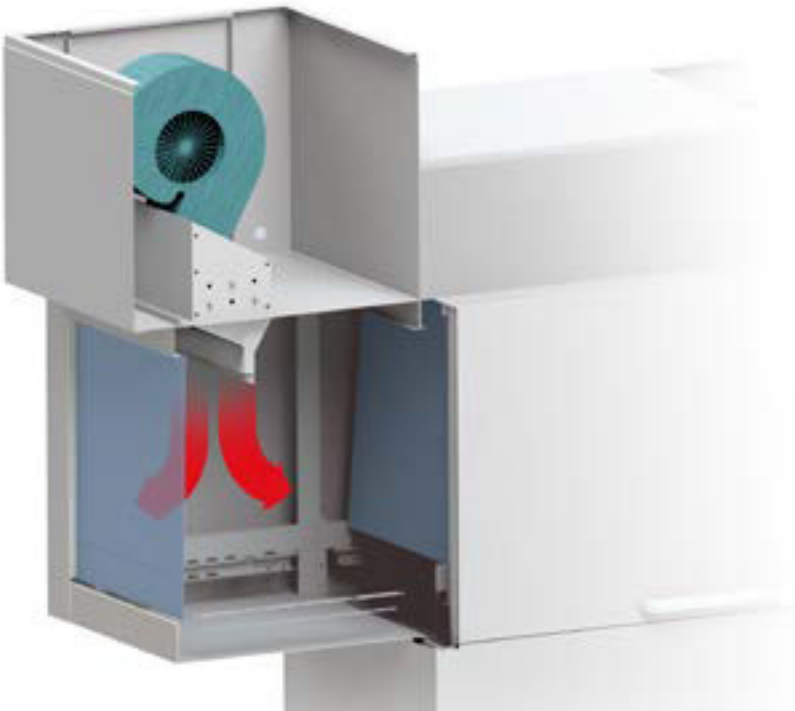

SC10
Steam condenser

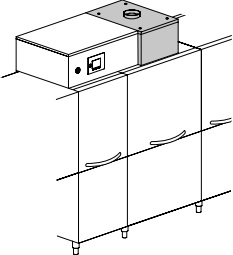

HR10
Compact heat recovery

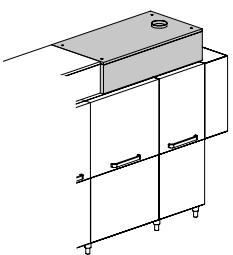

HR20
Heat recovery

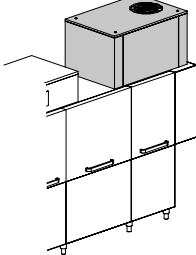

HRP30
Heat recovery with heat pump

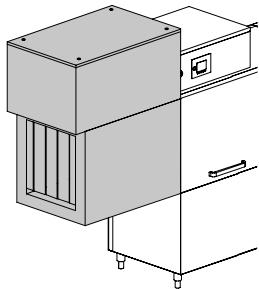

DR94 4.5kW
DR99 9kW
DR9V Steam Blower

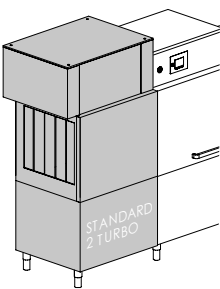

TB94 11.6kW
TB99 16.1kW
TB9V Steam Blower on module

		RC 231	RC 231 SPECIAL	RC 281	RC 301	RC 301 SPECIAL	RC 401	RC 401 SPECIAL
		electric	electric	electric	electric	electric	electric	electric
Advancement speed	m/min	1,5-2	1,5-2	1,5-2	2-2,6	2-2,6	2,6-4	2,6-4
Power supply	kW	400V 3N 50Hz	400V 3N 50Hz	400V 3N 50Hz	400V 3N 50Hz	400V 3N 50Hz	400V 3N 50Hz	400V 3N 50Hz
Useful passage	mm	510x500 H	510x500 H	510x800 H	510x500 H	510x500 H	510x500 H	510x500 H

PRE WASH

Wash pump	kW	-	-	-	1,25	1,25	2,18	2,18
Pump capacity	l/min	-	-	-	500	500	500	500
Tank capacity	l	-	-	-	95	95	95	95

REINFORCED WASH

Wash pump	kW	2,18	2,18	2,18	2,18	2,18	2,18	2,18
Pump capacity	l/min	650	650	700	650	650	650	650
Tank capacity	l	110	110	110	110	110	110	110
Heating	kW	12	12	12	12	12	12	12

RINSE

Water consumption	l/hr	280	280	320	345	345	400	400
Water pressure	kPa	150 / 600	150 / 600	150 / 600	150 / 600	150 / 600	150 / 600	150 / 600
Power supply	kW	29,4/2,4	29,4	32,4	36,65/3,65	36,65/3,65	40,58/4,58	40,58/4,58

DIMENSIONS (L x W x H)

Standard	mm	2600x805x1830 /2120	2710x805x2090 /2120	2800x805x2130 /2420	4100x805x2090 /2120	4100x805x1830 /2120	4100x805x1830 /2120	4100x805x2090 /2120
----------	----	------------------------	------------------------	------------------------	------------------------	------------------------	------------------------	------------------------

RT SERIES WASHERS

The RT series crate washers have been designed to wash crates, tubs, bins and buckets of varying size for the food processing industries. The belt on the RT models allows for different sizes and shapes to be washed without modifications.

The working direction of this range can be ordered to suit different operations.



STANDARD FEATURES

- SMART DRIVE 5-speed advancement system which allows for the ability to change speed based on contamination level
- 710 mm wide conveyor
- Standard crate belt
- IPX5 electronic board
- Centralised 1-Drain and automatic AD drain for ease of use. There is one drain connection point
- Wash and rinse economisers
- Reinforced double rinse 2R+, improved efficiency with lower water consumption

OPTIONS

- Double belt or lower belt conveyor available
- HACCP supervisor
- Cloud
- 3 available heat recovery systems
- Steam condenser
- Blowers to get rid of excess water
- Detergent pump
- Automatic self-cleaning of the machine available, with dedicated booster pump. To ensure cleanliness of machine
- Heavy duty belt to withstand heavy items
- Extra power if hot water is not available

		RT 490	RT 580	RT 670	RT 760	RT620HD	RT750HD
		electric	electric	electric	electric	electric	electric
Advancement speed	m/min	2,20-3,45	3,25-5,10	4,45-6,95	5,27-8,23	1,4-2,15	1,95-3
Power supply	kW	400V 3N 50Hz	400V 3N 50Hz	400V 3N 50Hz	400V 3N 50Hz	400V 3N 50Hz	400V 3N 50Hz
Useful passage	mm	710x450 H	710x450 H	710x450 H	710x450 H	710x450 H	710x450 H
PRE WASH							
Wash pump	kW	-	2,18	2,18	2,18	3	3
Pump capacity	l/min	-	650	650	650	1000	1000
Tank capacity	l	-	110	110	110	110	110
1st WASH							
Wash pump	kW	2,18	2,18	2,18	2,18	3,25	3,25
Pump capacity	l/min	650	650	650	650	1000	1000
Tank capacity	l	110	110	110	110	110	110
Tank heating element	kW	14	14	12	12	14	12
2nd WASH							
Wash pump	kW	-	-	2,18	2,18	-	3,25
Pump capacity	l/min	-	-	650	650	-	1000
Tank capacity	l	-	-	110	110	-	110
Tank heating element	kW	-	-	14	12	-	14
3rd WASH							
Wash pump	kW	-	-	-	2,18	-	-
Pump capacity	l/min	-	-	-	650	-	-
Tank capacity	l	-	-	-	110	-	-
Tank heating element	kW	-	-	-	14	-	-
DOUBLE RINSE							
Water consumption	l/hr	315	370	500	600	340	450
Boiler heating element	kW	15	18	24	27	16,5	20
Boiler capacity	lt	10x2 -7,5	10x2 -7,5	10x2 -7,5	10x3 -7,5x2	10x2 -7,5	10x3 -7,5
Tank capacity	lt	12	12	12	12	12	12
Pump	kW	0,2	0,2	0,2	0,2	0,2	0,2
Pump capacity	lt/min	120	120	120	120	120	120
Driving motor	kW	0,22	0,22	0,22	0,22	0,22	0,22
Power supply*	kW	32-2,6	37-4,8	57-7	74,2-9,2	37,2-7	56-10
DIMENSIONS							
Standard	mm	4900x985x1860 /2200	5800x985x1860 /2200	6700x985x1860 /2200	7600x900x1750 /2210	6200x985x1860 /2200	7500x985x1860 /2200

* Feeding water 55°C

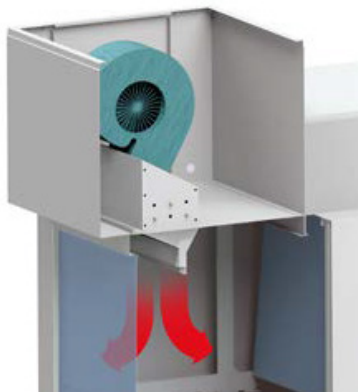

HEAT RECOVERY

RT OPTIONAL ZONES, BLOWERS & HEAT RECOVERY

The heat recovery allows cold water to be supplied to the machine which significantly saves energy.

The steam produced by the machine operation (otherwise lost in the room) is recovered and led through the heat exchanger (air - water).

The energy of the steam is used to preheat (up to 45°C) the inlet water resulting in a reduction of energy consumption.

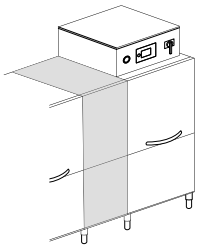

NZ3 + 300mm
Neutral zone

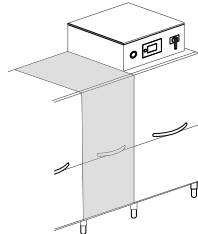

NZ6 + 600mm
Neutral zone with zone

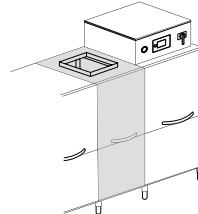

NZH6 + 600mm
Neutral zone with door for the blower

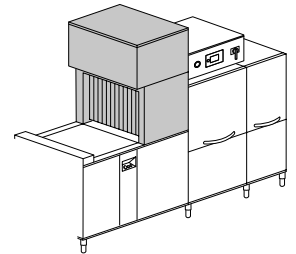

DRF69 9 kW
Shelf blower

DRF6V Steam
Steam heated shelf blower

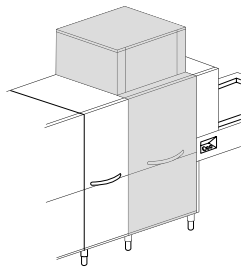

DRF99M + 900mm 9 kW
Stage blower

DRF9VM + 900mm steam
Steam heated stage blower

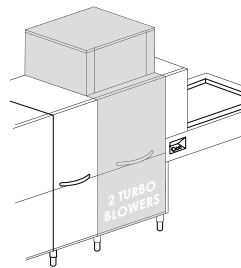

DRF99MB + 900mm 16.1 kW
Stage blower

DRF9VMB + 900mm steam 7.1 kW
Steam heated stage blower

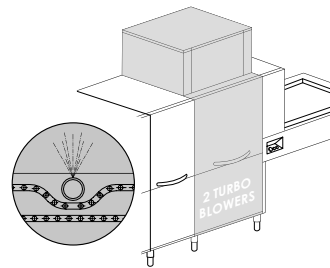

DRF99MB1 + 900mm 16.1 kW
Stage dryers with blowers and lower belt

DRF9VMB1 + 900mm steam 7.1 kW
Steam heated stage dryer with blowers and lower belt

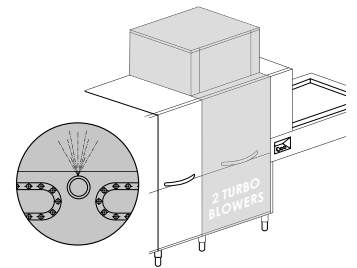

DRF99MB2 + 900mm 16.1 kW
Stage dryer with blowers and double belt

DRF9VMB2 + 900mm steam 7.1 kW
Steam heated stage dryer with blowers and double belt

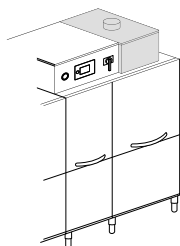

HRF10
Compact heat recovery

HRF10
Steam condenser

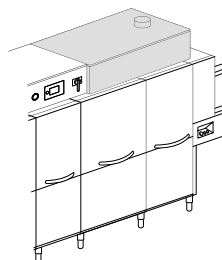

HRF20
Heat recovery

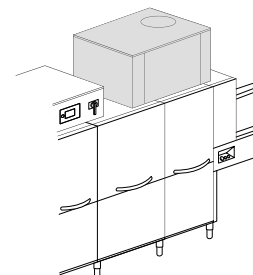

HRPF30
Heat recovery with heat pump

ACCESSORIES

ACCESSORISE YOUR RHIMA EQUIPMENT

Why should I use Rhima accessories?

Rhima accessories are produced and tested specifically for your equipment. We ensure you receive a solution, not just a piece of equipment.

ROLLER TABLES

Available in various lengths:

- 1100mm
- 1600mm
- 2100mm
- or custom.

We can also modify to suit your requirements and provide storage and sinks.

Each table comes with an end limit switch.

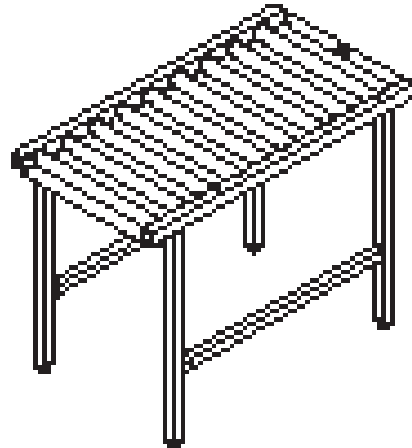

CURVE 90°/180°

90° or 180° curves available to connect your machine to roller tables if limited space available.

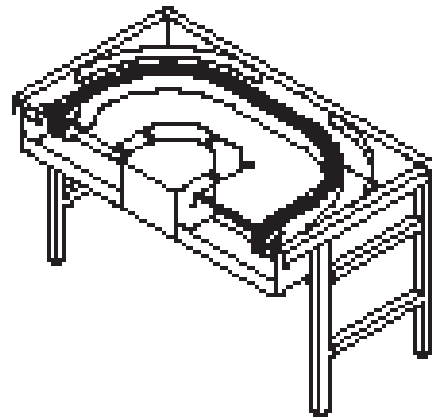

DETERGENT PUMP

To automatically dispense chemicals into the wash & rinse cycles.

RHIMA CARE

SERVICE AND MAINTENANCE FOR YOUR WASHER

Does my washer need regular service and maintenance?

Whether your Rhima washer is in or out of warranty, it needs regular professional maintenance to ensure it is operating at optimum performance.

Regular maintenance can also reduce running costs and greatly extend your washer's useful life. As importantly, a well serviced machine helps to safeguard against unexpected, inconvenient, expensive breakdowns.

Does my washer comply with HACCP guidelines?

Your Rhima washer is a commercial grade appliance that is designed to wash and sanitise your items to local council and health department guidelines. To ensure that your machine meets these requirements, it should be regularly tested by our experienced technicians who will ensure it complies with safety, hygiene and operational standards. A test report is provided for your records.



My washer needs to be fixed and it's 11AM on a Sunday morning. Who do I call?

Rhima provides professional washing equipment to professionals just like you. We understand that businesses do not all operate 9 to 5 and neither do we. Call us at anytime and a service representative will respond to your call. Our first priority is to try to get you operational over the phone, however if this is not possible, you will be given the option of waiting until the next business day to log a service call or if you can't wait, then in most cases a service technician will be arranged to attend your premises as soon as possible, usually same day.

BENEFITS OF RHIMA PREVENTATIVE MAINTENANCE

- Improved washer efficiency and reliability
- Priority service in the event of repairs being required
- Reduction in unexpected breakdowns and costly stoppages
- Savings on total maintenance costs
- Optimisation of detergent and rinse additive usage
- Prolonged service life
- 24/7 service response
- First 2 hours of labour on breakdowns*

*Callout fee applies. Not valid for faults not directly related to washer i.e. interruption to services (power, water & drainage) or operator

We can tailor a Rhima Care Preventative Maintenance Agreement to suit your needs including a HACCP test if required.

CLEANING AND CARE

CHEMICALS FOR YOUR RHIMA EQUIPMENT

Why should I use Rhima detergents?

Rhima detergents are produced locally under strict quality control and have been specially formulated for use in Rhima washing equipment. Rhima's range of detergents and rinse additives, are full strength, concentrated products that will not only give superior wash results by allowing you to use less, but will also save you money without sacrificing quality. Please talk to us about which Rhima detergent products are perfect for your application.

SUPERWASH 10 Litre

A liquid washing detergent specifically designed for washing soiled items across the hospitality and industrial industries. Only to be used in combination with an automatic dispenser. Comes in 1 x 10L boxes.



FINAL RINSE 5 Litre

Automatically added to the rinse cycle of the washer to assist rapid drying and reduce spotting and streaking of plates & glassware. Only to be used with automatic dispensers. Available in 2 x 5L carton.





rethink
reuse
rhima



Rhima Australia Pty Ltd
www.rhima.com.au
Tel: 1300 347 944

Rhima New Zealand
www.rhima.co.nz
Tel: +64 9414 5575

Rhima Singapore
www.rhima.sg
Tel: +65 9107 8943